

Spinning Flower

Designed by Gadi Vishne

Copyright ©2007. All Rights Reserved.

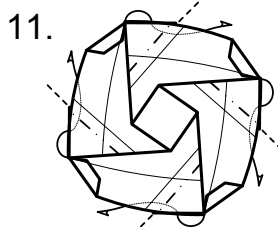
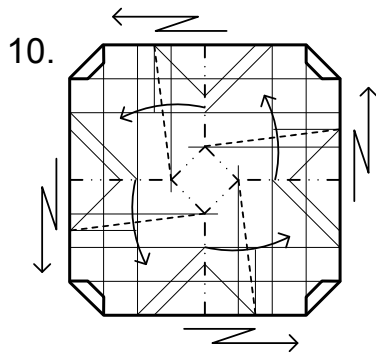
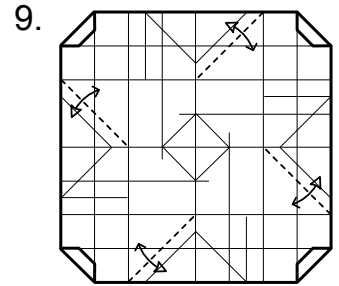
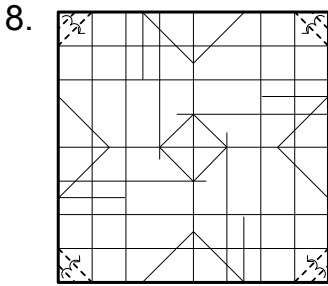
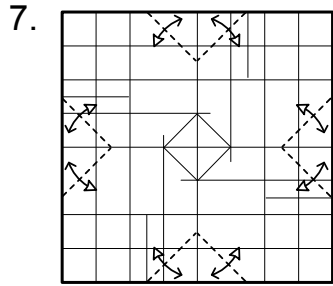
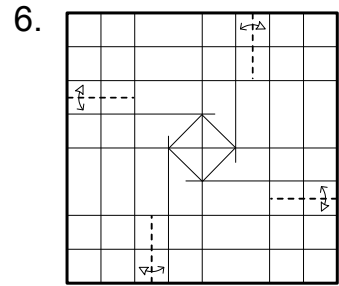
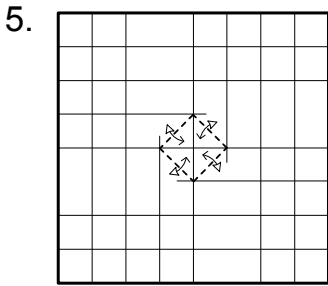
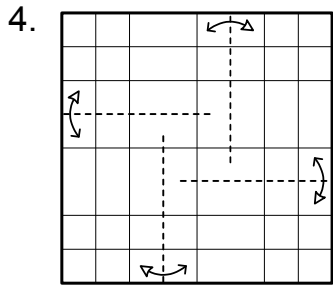
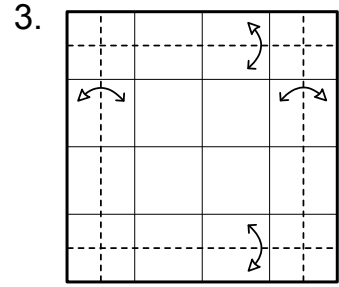
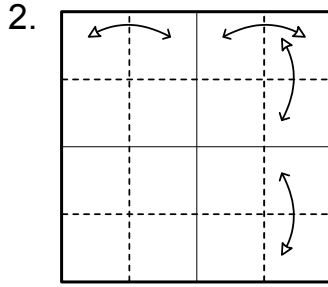
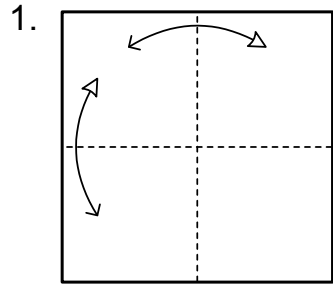

At this stage the paper is not flat any more.

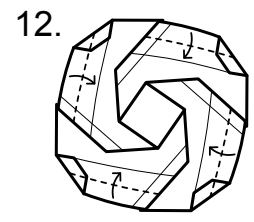

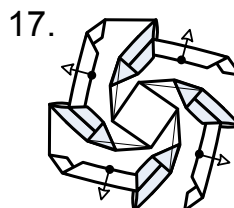
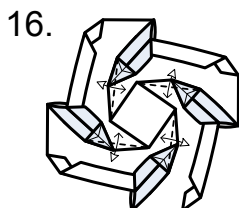
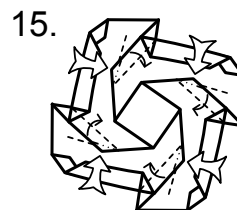
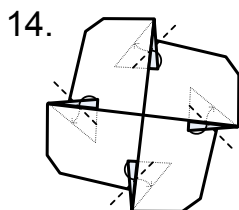
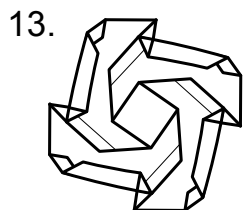

Pull the marked flaps a little up.

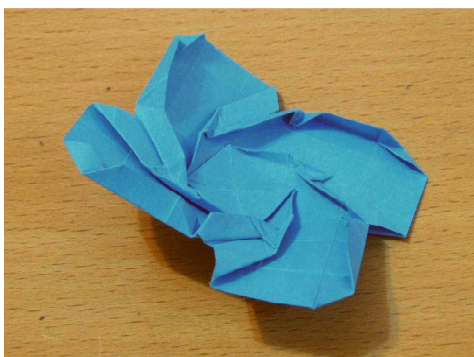

Blow on this flower to make it spin around.

